

# Data Sheet



Article number: 0105039

Description: Retaining ring AV 22

Note: Fitted with ZGA pliers

## Measures

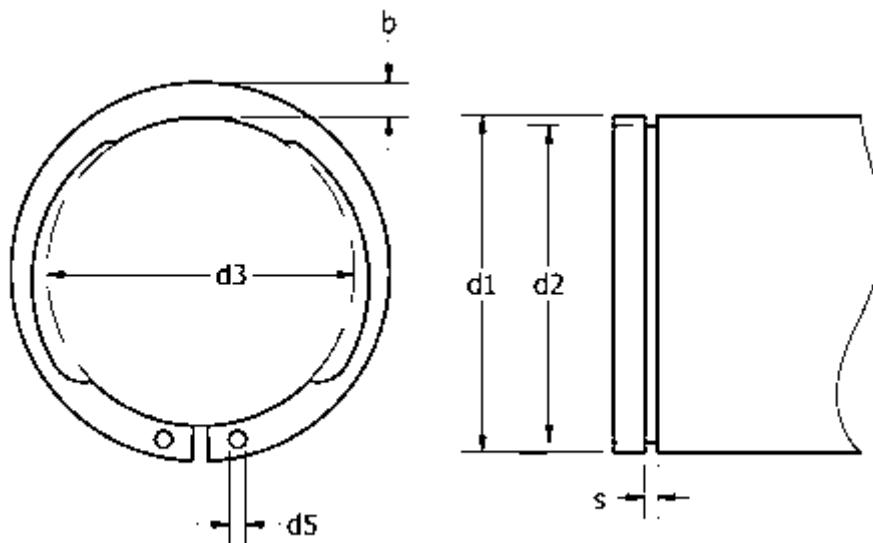

AN mm <sup>2</sup>	= 15.2	FRg kN	= 3.1	t	= 0.50
b	= 3.0	FR kN	= 14.2	tol	= -0.06
d1	= 22	g	= 1.5	tol	= -0.15
d2	= 21.0	K kN-mm	= 29.7	tol	= +0,13-0,42
d3	= 20.50	m min	= 1.30	tol	= 0.1
d5 min	= 1.5	n abl x 1000	= 27	Tong	= ZGA-1
Description	= AV 22	s	= 1.20	Weight kg/1000	= 1.63
FN kN	= 2.53	Side power N at I2	= 1.5		